



Central inverter

PVS980-58

FIMER central inverters raise reliability, efficiency and ease of installation to new levels. The inverters are aimed at system integrators and end users who require high-performance solar inverters for large photovoltaic (PV) power plants and are optimized for cost-effective, multi-megawatt power plants.

From 1818 to 2091 kVA



Solar inverter **PVS980-CS**

The FIMER compact skid is a plug-and-play solution designed for large-scale solar power generation using PVS980-58 high-power central inverters.

It houses all the electrical equipment that is needed to rapidly connect a photovoltaic (PV) power plant to a medium voltage (MV) electricity grid.

Up to 4600 kVA

Turnkey-solution for PV power plants

The FIMER compact skid design capitalizes on FIMER's long experience in developing and manufacturing solutions for utilities and major end users worldwide in conventional power transmission installations.

A skid houses one or two outdoor 1818 to 2091 kVA FIMER PVS980-58 central inverters, an optimized MV oil immersed transformer, MV switchgear and all needed auxiliary services. The FIMER compact skid is used to connect a PV power plant to a MV electricity grid easily and rapidly. To meet the PV power plant's demanded capacity, several FIMER compact skids can be used.

Compact design eases transportation

The compact skid solution has dimensions suitable for transportation inside closed 40 feet High Cube shipping container. The total package weighs less than 24 tons. The standardized shipping dimensions ensures cost-effective and safe transportability to the site, even overseas.

Inverter's optimized air circulation and filtering system, together with hermetically sealed oil immersed transformer enable installations in various ambient conditions, from harsh desert temperatures to cold and humid environments. The FIMER compact skid is designed for at least 25 years of operation.

Highlights

- Proven technology and reliable components
- Compact and robust design
- Outstanding endurance for outdoor use
- High DC input voltage up to 1500 V_{DC}
- High total efficiency
- Extensive DC and AC side protection
- Self-contained cooling system for inverters
- Modular and serviceable system
- Embedded auxiliary power distribution system
- Extendable manufacturing footprint with fast deliveries
- Global life cycle services and support
- Transportable inside closed 40 feet HC shipping container
- Arc-proof design

Compact skid design and grid connection

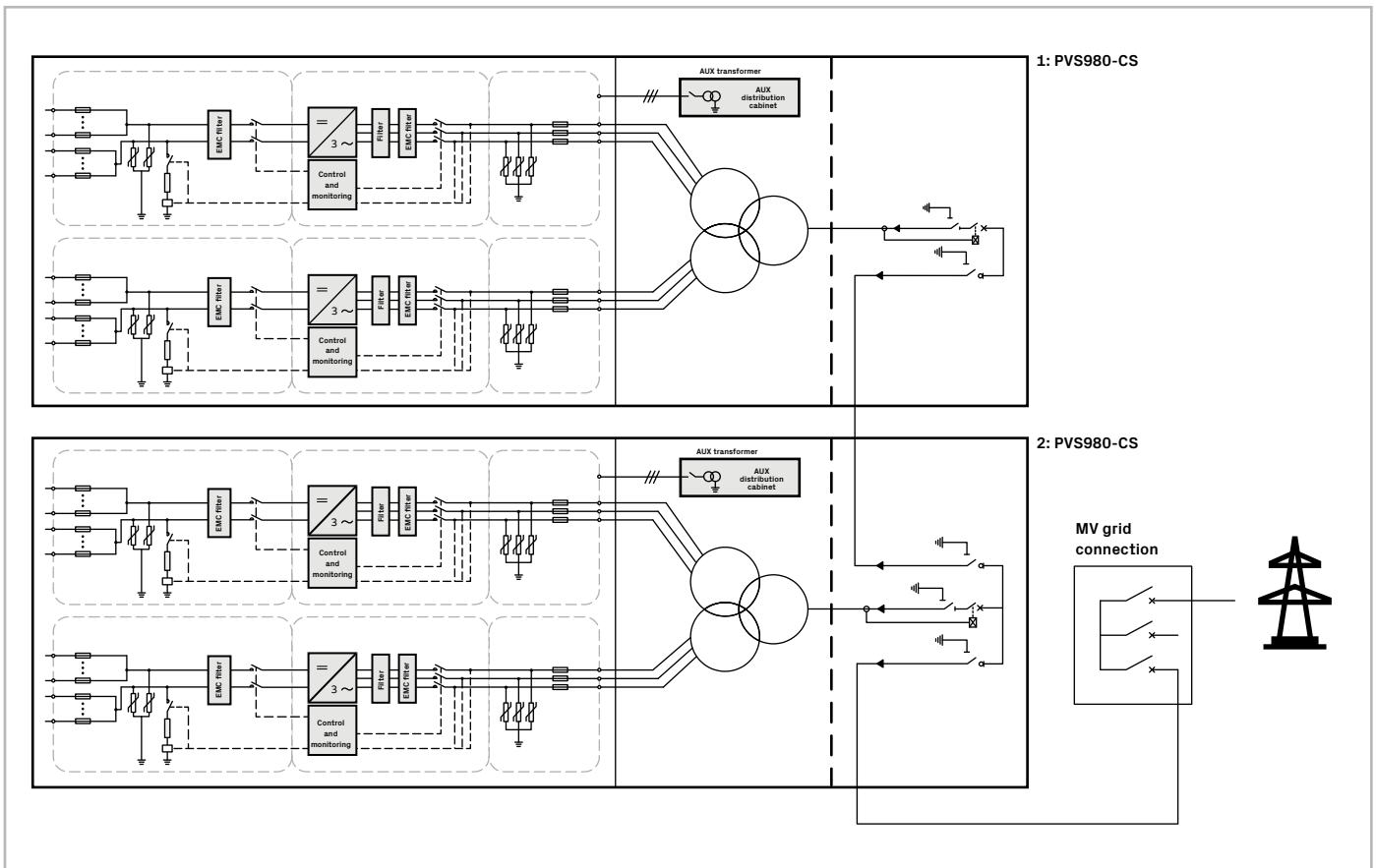

PVS980-CS

Solar inverters

Like other FIMER central inverters, the PVS980-58 has been developed on the basis of decades of experience in the industry and proven technology platform. Unrivalled expertise from the world's market and technology leader in frequency converters is the hallmark of this solar inverter series.

The PVS980-58 inverter is one of the most efficient and cost-effective ways of converting the direct current (DC) generated by solar modules into high quality and CO₂-free alternating current (AC) that can be fed into the power distribution network. One or two FIMER central inverters are used in the FIMER compact skid. The inverters provide high conversion efficiency with low auxiliary power consumption, as well as very low maintenance need.

Transformer

The FIMER compact skid includes an oil immersed transformer. The transformer is designed to meet the reliability, durability and

efficiency required in PV applications. It is specifically designed and optimized for FIMER solar inverters to provide the best performance throughout the lifetime of the plant.

Different power transformers are available to meet customer requirements. All transformers are manufactured in accordance with the most demanding industry and international standards.

Switchgear

The FIMER compact skid is equipped, as standard, with the widely proven SF₆-insulated switchgear.

A sealed steel tank with constant atmospheric conditions ensures a high level of reliability as well as personnel safety. The virtually maintenance-free system comes in a compact and flexible design that allows for a versatile switchgear configuration with arc-proof capability.

Technical data and type

Type code	2.0MVA	2.1MVA	2.2MVA	2.3MVA	4.0MVA	4.2MVA	4.4MVA	4.6MVA
Maximum rating in kVA	2000	2100	2200	2300	4000	4200	4400	4600
Inverter								
Inverter	PVS980-58, 2.0 - 2.3MVA							
Maximum operating DC input voltage	1500 V							
Number of inverters	1	1	1	1	2	2	2	2
Number of independent MPPT	1	1	1	1	2	2	2	2
MPPT range @ 35° C in V	850-1500	893-1500	935-1500	978-1500	850-1500	893-1500	935-1500	978-1500
MPPT range @ 50° C in V	850-1100	893-1100	935-1100	978-1100	850-1100	893-1100	935-1100	978-1100
AC output voltage	600 V	630 V	660 V	690 V	600 V	630 V	660 V	690 V
MV transformer								
Transformer type	Oil immersed (ONAN)							
AC Power @ 35° C in kVA	2000	2100	2200	2300	4000	4200	4400	4600
AC Power @ 50° C in kVA	1818	1909	2000	2091	3636	3818	4000	4182
Number of secondary windings	1	1	1	1	2	2	2	2
Low voltage level	600 V	630 V	660 V	690 V	600 V	630 V	660 V	690 V
Medium voltage level range	≤ 36 kV							
Rated frequency	50Hz or 60 Hz							
Oil type	Mineral (vegetable optional)							
Tap changer	± 2 x 2.5%							
Winding material (primary / secondary)	Al / Al							
Eco efficiency optional	Yes							
MV switchgear								
Switchgear type	SF6-insulated							
Rated current	630 A							
Configuration	Single (CV) or double feeder (CCV)							
Protection (up to 24 kV / up to 36 kV)	Circuit breaker (16 kA or 20 kA / 20 kA or 25 kA)							
Protection relay type	REJ603 (others on request)							
Motorized optional	Yes							

Technical data and type

Type code	2.0MVA	2.1MVA	2.2MVA	2.3MVA	4.0MVA	4.2MVA	4.4MVA	4.6MVA
Auxiliary supply								
Auxiliary transformer power	10 kVA (20kVA, 30kVA optional)							
Auxiliary transformer primary voltage level	600 V	630 V	660 V	690 V	600 V	630 V	660 V	690 V
Auxiliary transformer secondary voltage level	400-230 V							
Low voltage distribution panel for auxiliary functions	Yes							
Mechanical characteristics								
Dimensions (length x width x height) in mm	11850 x 2150 x 2570 (40ft HC container dimensions)							
Weight approx. in ton	17	17	17	17	24	24	24	24
Environmental								
Operating temperature range	-20° C ... +50° C							
Operating altitude range	≤ 2000 m							
Relative humidity (non-condensing)	≤ 95%							
Environmental protection rating	IP 54 (IP 66 for inverter)							
Painting corrosion protection	C4 (C5M optional)							
Product compliance								
Conformity	IEC 60364, IEC 61936-1, IEC 60502-1							
Grid support	Reactive power compensation (also at night), power reduction, LVRT, HVRT, FqRT							

MV switchgear standard configurations for FIMER compact skid

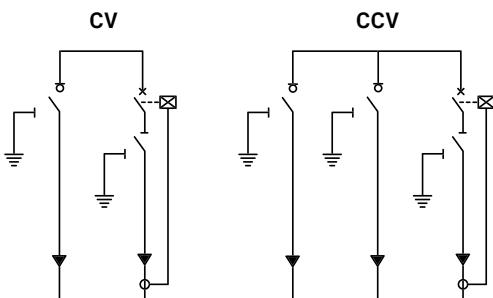

Accessories

- Solar array junction boxes with string monitoring
- Remote monitoring solutions
- Warranty extensions

Options

- MV AC output voltages up to 36 kV
- Different MV switchgear configurations
- I/O extensions
- DC grounding, positive
- Floating DC

- Fieldbus and Ethernet connections
- Auxiliary power supply up to 40kVA
- C5M enclosure corrosion protection

Support and service

FIMER supports its customers with a dedicated global service network and provides a complete range of life cycle services from installation and commissioning to preventative maintenance, spare parts, repairs and recycling.



For more information please contact your local FIMER representative or visit:

fimer.com

We reserve the right to make technical changes or modify the contents of this document without prior notice. With regard to purchase orders, the agreed particulars shall prevail. FIMER does not accept any responsibility whatsoever for potential errors or possible lack of information in this document.

We reserve all rights in this document and in the subject matter and illustrations contained therein. Any reproduction, disclosure to third parties or utilization of its contents – in whole or in parts – is forbidden without prior written consent of FIMER. Copyright© 2020 FIMER. All rights reserved.





Tracker Configurations

Tracking system:	Horizontal Single-Axis Tracker
Tracking range:	100° (±50°)
Length of tracking system:	Up to 90 modules
System voltage:	1,000 volt or 1,500 volt
Module configurations:	1 module vertical

Mechanical Specifications

Structure:	Galvanized steel
Foundations:	C-Profiles/Sigma profiles
Storm position:	10°
Vibration dampening:	Gas shock absorbers
Wind tunnel tested:	Up to 145 mph
Corrosion protection standard:	C3
Maximum site slope:	North-South 10,5 % / 6° East-West 14,0 % / 8°

Driving System

Gear type:	Slewing drive
Voltage:	24 V DC
Protection class:	IP65r

Control System

Communication:	Wireless ZigBee® - no wiring
Tracking control system:	Proprietary algorithm
Powering:	String-powered
Backtracking:	Included with integrated inclination sensors
Weather Monitoring:	Anemometer & Snow sensor

Installation & Maintenance

Installation:	Quick installation without cutting, drilling or welding
Driving system:	Prelubricated
Pivot bearings:	No lubrication required
Shock absorbers:	Maintenance free
Maintenance interval:	2 years
Control unit:	Maintenance free

Warranty

Drive:	5 years
Control system:	5 years
Structure:	10 years
Design life:	25 years

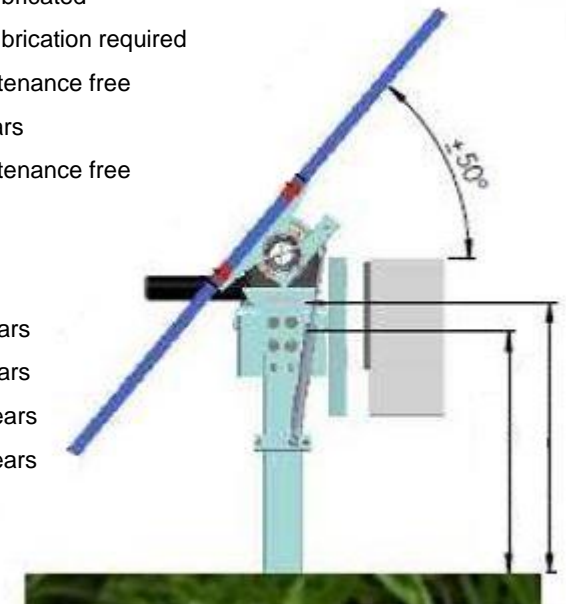

ZIM Track Single-Axis Tracker System

A high quality, large scale PV Tracker System

Agenda

- Company overview
- Track record
- Advantages
- ZIM Track
- Operation and maintenance
- Quality and warranty statement
- Impressions of system
- Summary

Company overview

- Zimmermann PV-Stahlbau GmbH & Co. KG
Germany
(Niederlassung in der Türkei)
- Zimmermann PV-Tracker GmbH
Germany
- Zimmermann PV Racking North America Inc.
Canada
- Zimmermann PV Racking USA Inc.
USA
- PV-Floating B. V.
Netherlands

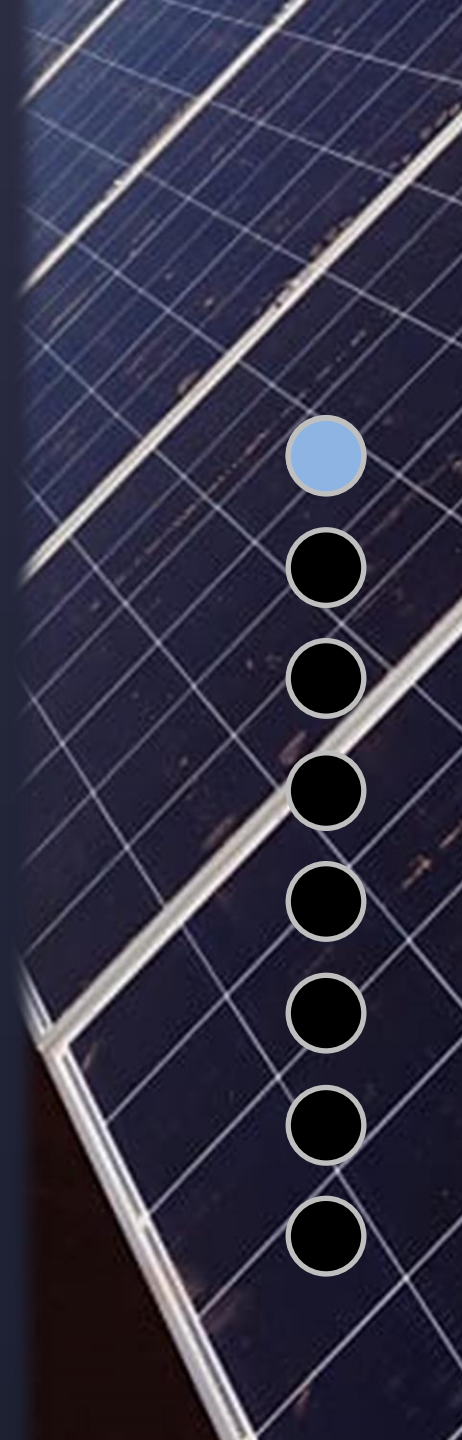

Company overview

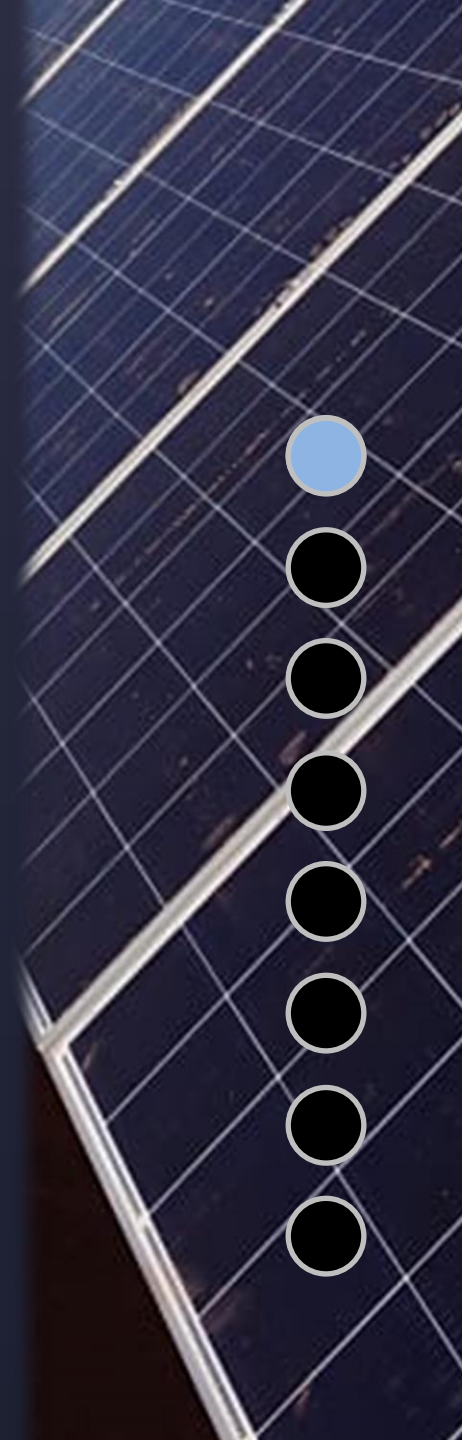
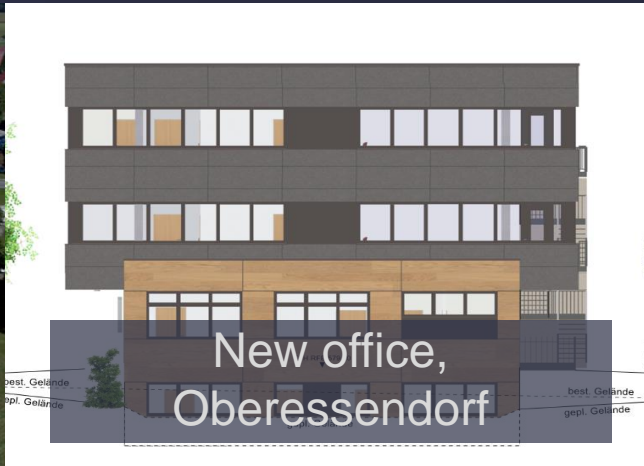

Company overview



Track record

419 MW

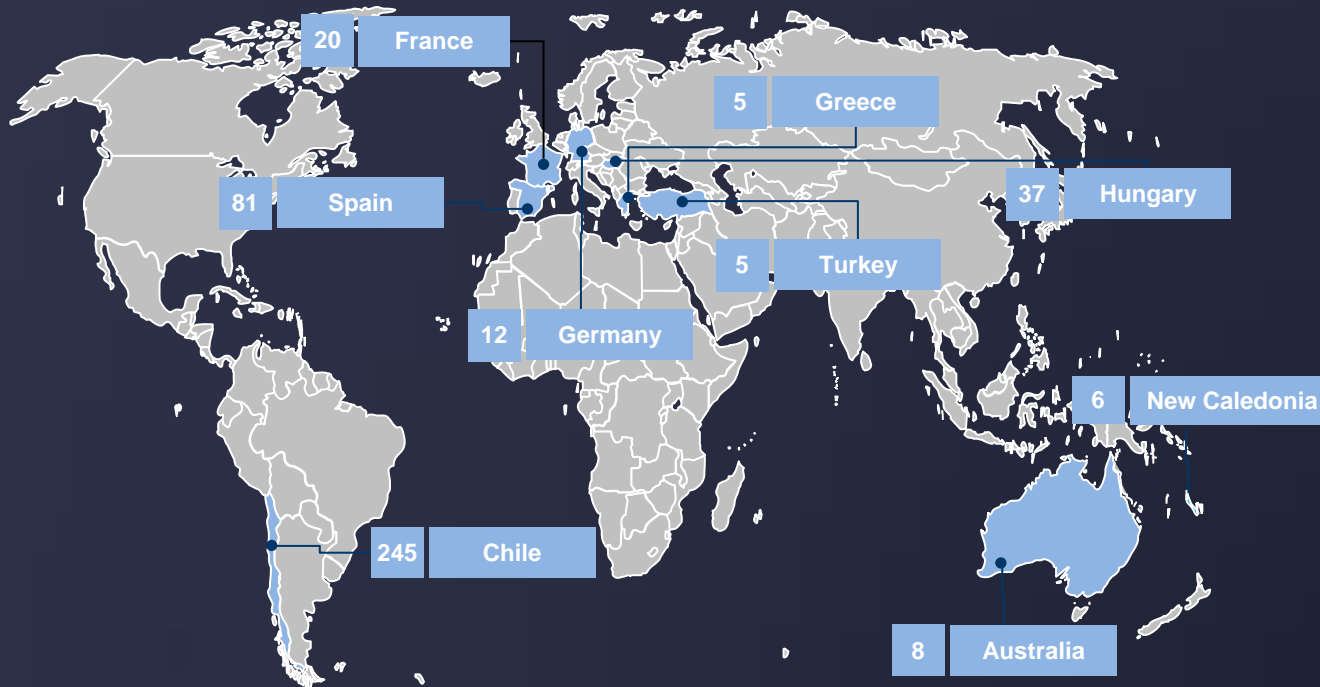

Advantages

A high quality, large scale PV Tracker System

- Strong and rigid construction.
- Fast and easy assembly e.g. integrated hook for module assembling, low quantity of components and high standardisation. Only bolted connectors, no welding, cutting and drilling at project site required.
- **Patent pending for innovative module bracket with integrated nut, hook for fast module installation, screw lock and earthing***.
- Low maintenance system and easy replacement of components including the gearbox without disassembly of the structure.
- **Integrated cable management (safe and protected, no extra components necessary) ***
- Weather protected inverter mounting possible, shelter from rain and overheating.
- Backtracking - independent row tracking.
- Monitoring portal for the trackers. ***Unique advantage, only**

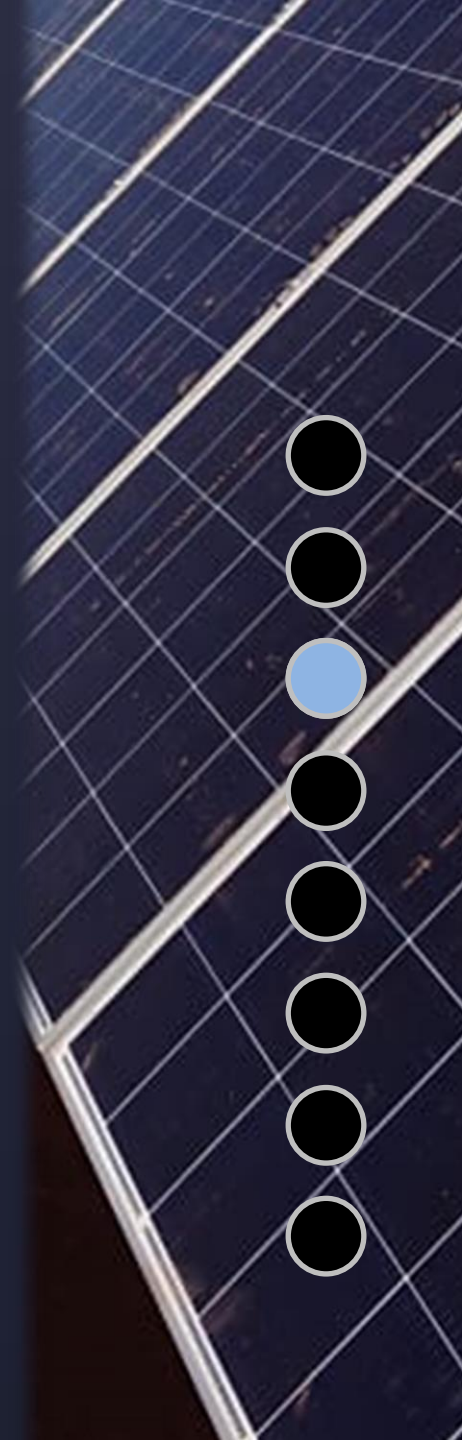

Advantages

A high quality, large scale PV Tracker System

- Cleaning position can be configured as required without barriers – therefore no interruption in cleaning process. The cleaning position can be activated fast and easy by activating a switch at the central unit.
- Simple and fast commissioning, which can be executed by the customer.
- Weather stations with anemometers and snow sensors for exact and reliable measurements are integrated in the system.
- The assembling and maintenance of the whole system is possible with standard tools, no expensive special tools is necessary.
- **Moderate tolerances for easy installation – deviations can easily be aligned*.**
- Wind tunnel tested up to 145 mph.
- Rows up to 90 modules (1 x 2m).

***Unique advantage, only available at ZIM Track**

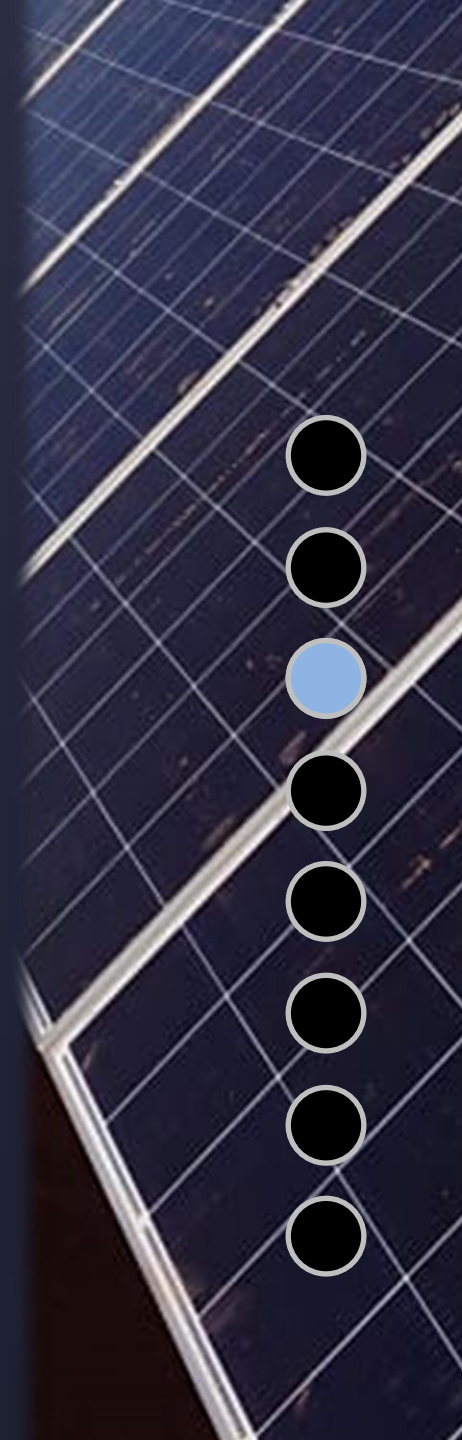

ZIM Track

We deliver a System, individual for each projects

- Projects specific structural calculation.
- Calculation of pile depth on basis of geological survey and providing of a ramming plan.
- Wind zone optimisation according to valid standards and norms.
- Optimisation and planning for tracker control system incl. integration of environmental sensors.
- Electrical concept and planning on request.

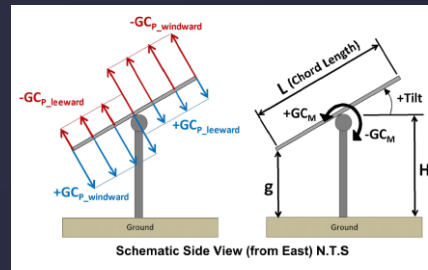
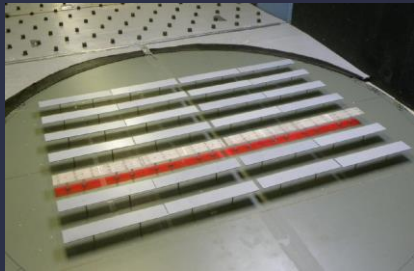

ZIM Track

Main Facts of Zim Track System

- Tracking Technology Horizontal Single-Axis with independent rows
 - Tracking Range $\pm 50^\circ$
 - Row length Up to 90 Modules
 - System Voltage 1,000 V and 1,500 V
 - Power Consumption Parasitic from the string
 - Maximum Site Slope North-South 6° / East-West 8°
 - Wind tunnel tested 145 mph
 - Operating Temperature Range -30°C to 60°C
 - Foundations C-Profiles or SIGMA
 - Backtracking Included with integrated inclination sensors
-
- We deliver a system including project specific planning.

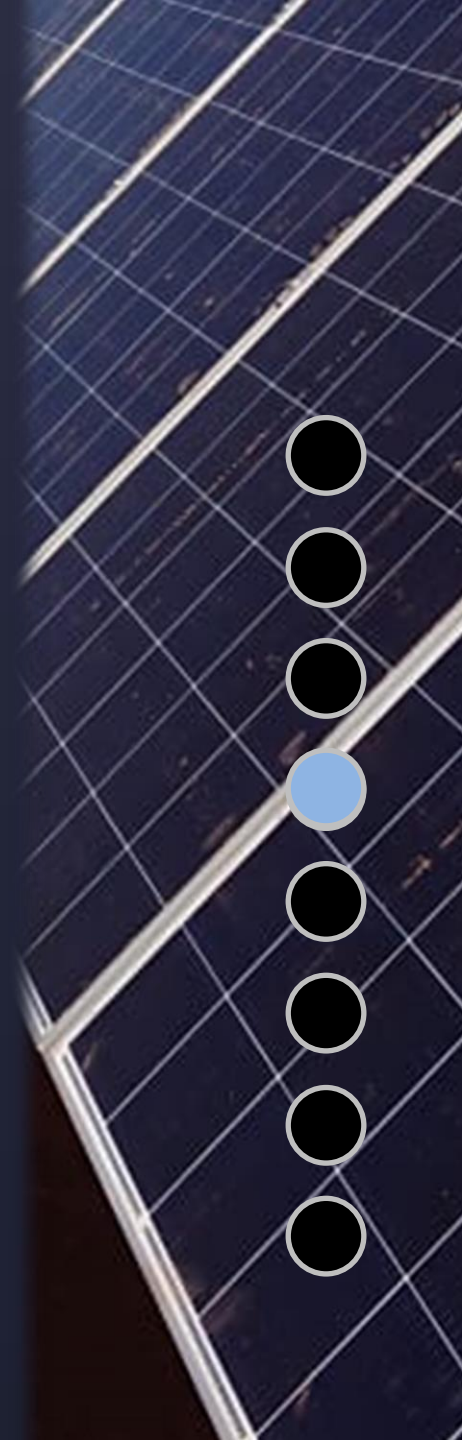

ZIM Track

Innovative Module holder

- Clamped to the hexagon tube.
- Adjustable to the module width.
- Well proven clamps with M8 bolts with integrated anti-rotation device.
- Integrated hooks for quick assembly.
- Integrated module grounding pins.

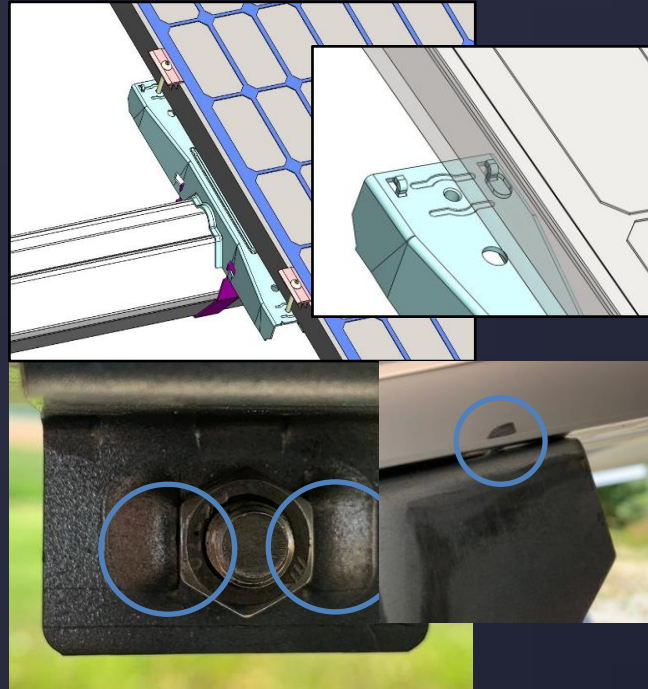

For the assembly the tracker can be turned to 50° and the modules can simply be hooked into the correct position. The clamps can be mounted quickly and easily in a comfortable position for the work force.



ZIM Track

Innovative Module holder

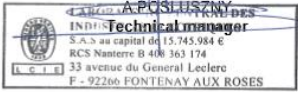
			
		Accreditation N°1-0311 Scope available on www.cofrac.fr	
TEST REPORT			
N°: 163595-742823		Version : 01	
Subject	Electrical tests according to a particular program on system for protective grounding of photovoltaic panels.		
Issued to	Zimmermann PV-Stahlbau GmbH & Co.KG Petrusstrasse 1 88436 OBERESSENDORF DEUTSCHLAND		
Apparatus under test	☞ Product '15130177a V09' ☞ Trade mark Zimmermann ☞ Manufacturer Zimmermann ☞ Model under test '15130177a V09' ☞ Serial number -		
Conclusion	Compliant		
Test date	November 2019		
Test location	LCIE - Fontenay-Aux-Roses		
Composition of document	09 pages		
Document issued on	December 03th, 2019		
Written by : L.SPENDEL Tests operator	Approved by : A.PCISLUSZNY Technical manager 		
<small>This document shall not be reproduced, except in full, without the written approval of the LCIE. This document contains results related only to the items tested. It does not imply the conformity of the whole production to the items tested. Unless otherwise specified or rule defined by the test method, the decision of conformity doesn't take into account the uncertainty of measures. This document doesn't anticipate any certification decision. The COFRAC accreditation attests the technical capability of the testing laboratory for the only tests covered by the accreditation. If some tests mentioned in this report are carried out outside the framework of COFRAC accreditation, they are indicated by an asterisk (*).</small>			
LCIE Laboratoire Central des Industries Electriques Une société de Bureau Veritas	33, Av du Général Leclerc 92266 Fontenay Aux Roses FRANCE	Tél : +33 1 40 95 60 60 contact@lcie.fr www.lcie.fr	
<small>SAS au capital de 15 745 984 € / RCS Nanterre B 408 363 174 / N° TVA intracommunautaire FR01 408 363 174 / N° SIRET 408 363 174 00017</small>			

ZIM Track

Main tube and shock absorber

Main Tube:

- Hexagonal tube SW 130 with one recess and prefabricated holes.
- The recess can be used as an integrated cable channel.
- Module holders are attached to the hexagonal tube.
- Hot-dip galvanized (EN ISO 1461 & EN 10346 or ZM310 / ZM430 / Z600)

Shock Absorber:

- Shock absorber effects mechanical relief of the tracker without additional energy.
- Quantity depending on the wind loads.
- Maintenance free device.

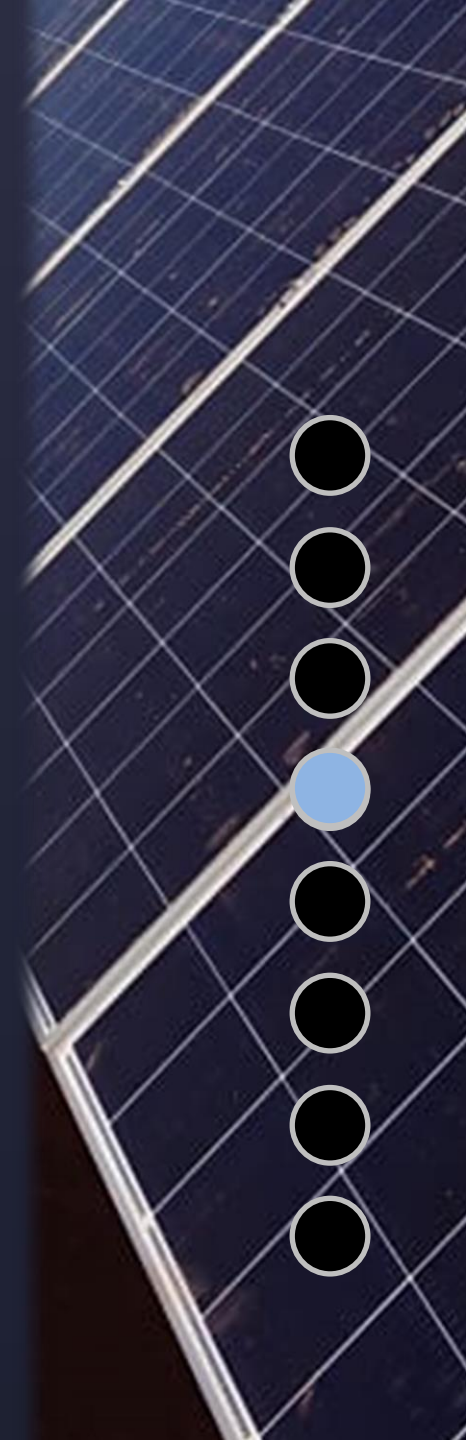

ZIM Track

Drive system

- Sturdy and reliable design of the gearbox and motor.
- The standard temperature working-range of a drive system is between -40°C and 60°C (-40°F to 140°F).
- Each drive system is pre-lubricated and must be lubricated only every 2 years.
- IP Class of 65.
- Easy opening and closing of flange.
- The drive system can be changed without disassembling of other parts (like on many other systems of other parts).

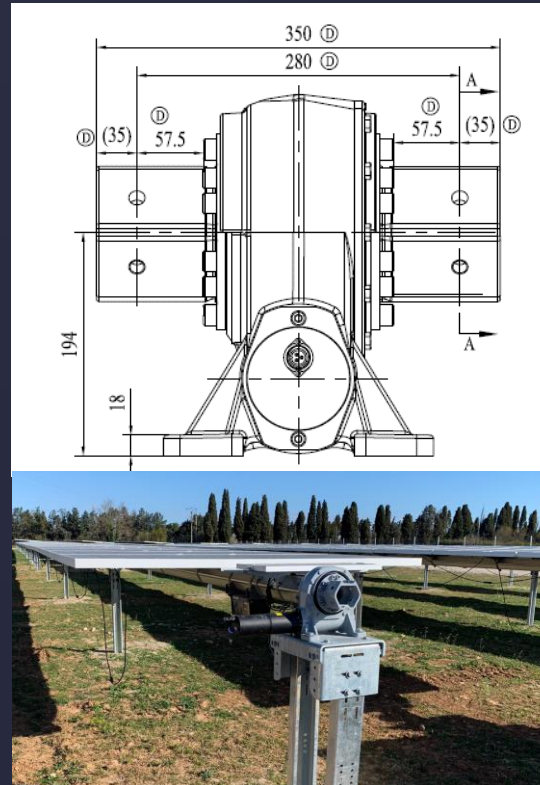

ZIM Track

Mounting of inverter

- Mounting position depending on individual electrical concept. For each concept we can provide the according inverter fixation.
- Optimal integration into the ZIM Track tracker system.



Operation and Maintenance

A low-maintenance system with less operating costs

- The ZIM Track is design particularly for a low-cost maintenance and repair.
- Only every two years the connection must be checked, and the gearbox must be greased.
 - Estimation in time: 2-3 days per MW in 2 years.
- Savings of around 35.000 EUR per MW by using the string powered system without battery (in lifetime of 25 years).
- Design lifetime of 25 years.
- Lubrication-free bearings made of UV-resistant plastic.
- Maintenance-free shock absorbers.
- In contrast to many competitors we supply a maintenance-free control unit (no batteries are installed that would need to be replaced after a few years).

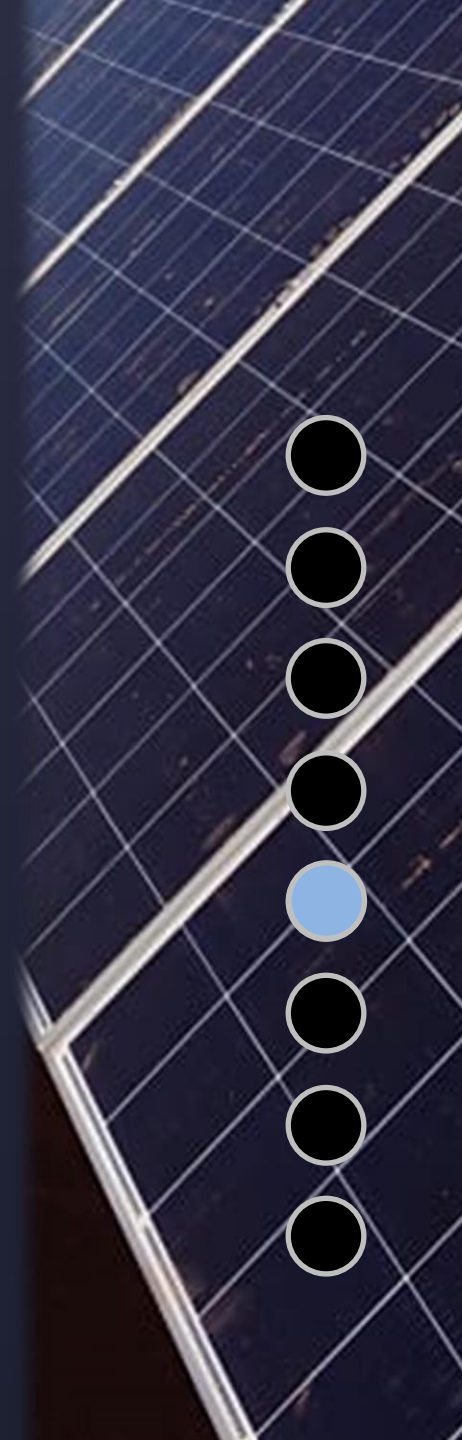

Operation and Maintenance

A low-maintenance system with less operating costs

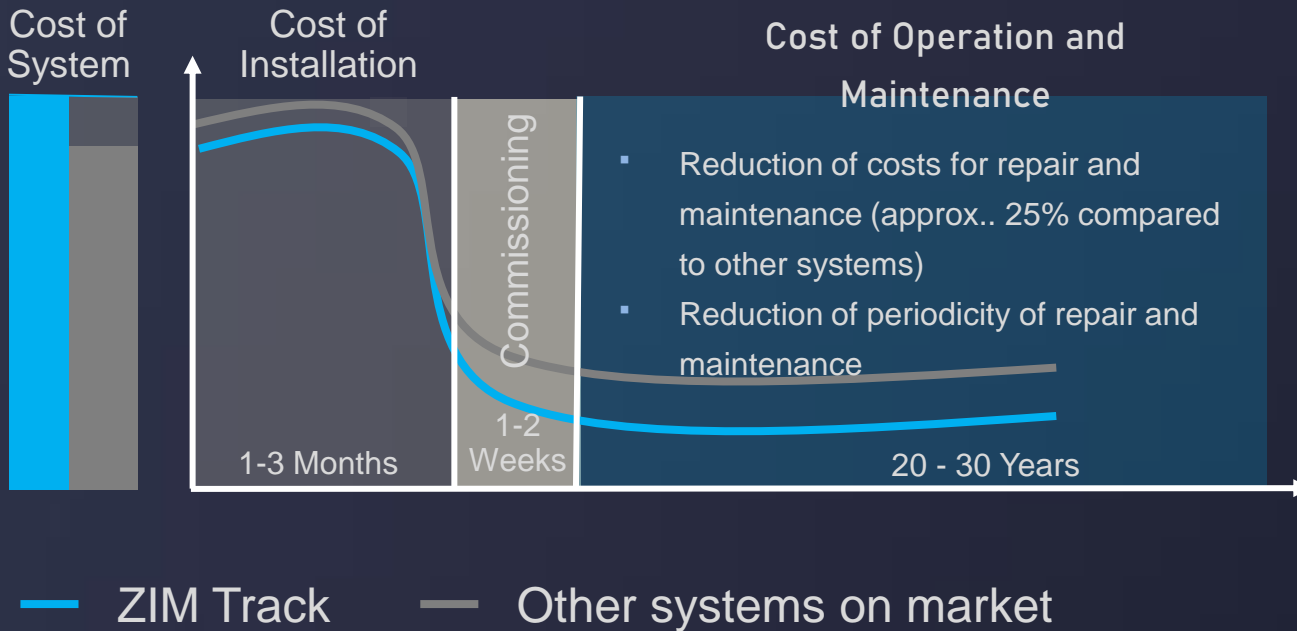

Quality/Warranty Statement

A reliable and high-quality system

- 10 years of warranty for the structure.
- 5 years warranty on electrical components.
- Design Life of 25 years.
- Simulation of drive unit for 2 years with around 140 cycles a day and total cycles of around 100.000. That equals around 90 years.
- Proof of conformity for Steel by EN 1090 (CE Declaration of Conformity) available.
- Quality management system according to ISO 9001: 2008.
- Certifications by Zimmermann PV-Stahlbau GmbH & Co.KG.
- Risk-Assessment by TÜV Rheinland in process.

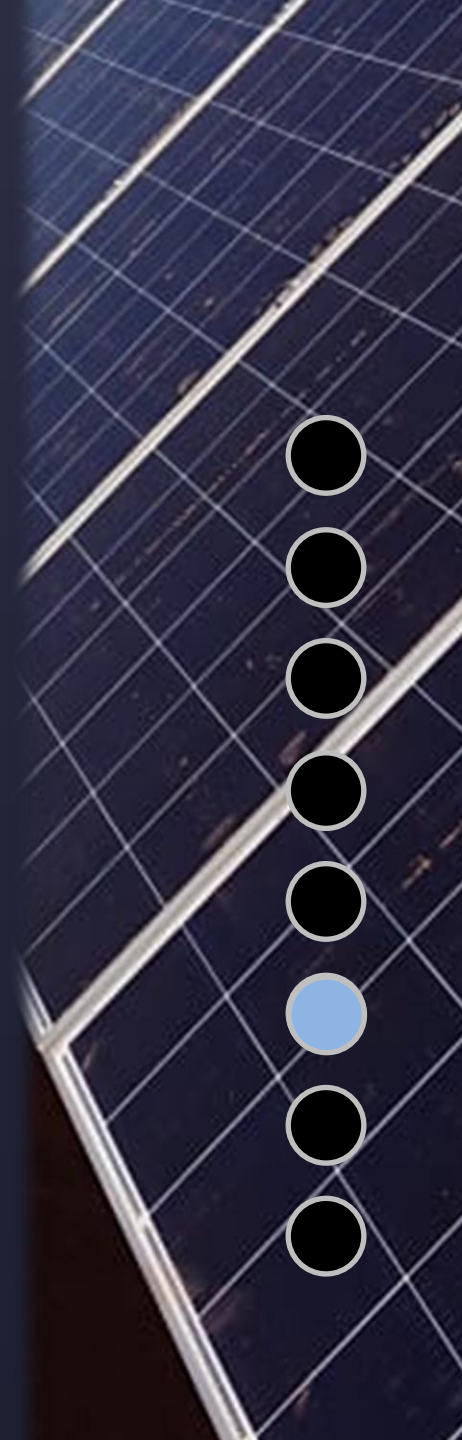

Impression of the system

Installation Process of ZM-Single-Axis Tracker



The substructure of the ZIM Tracker – with integrated cabling, earthing and shaded inverters.



Impression of the system

Installation Process of ZM-Single-Axis Tracker

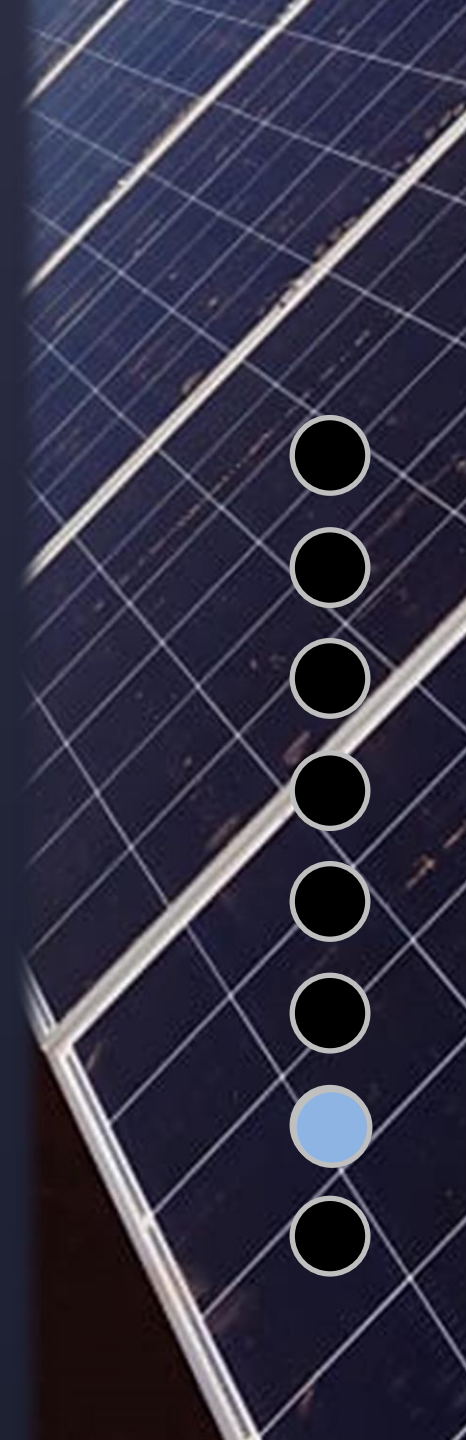

Impression of the system

Installation Process of ZM-Single-Axis Tracker



Impression of the system

Cleaning position



- The cleaning position can be activated fast and easy by activating a switch in the central unit.
- Cleaning is easy and can be performed fast and without barriers in the cleaning position.
- No interruption of the cleaning process per double row.

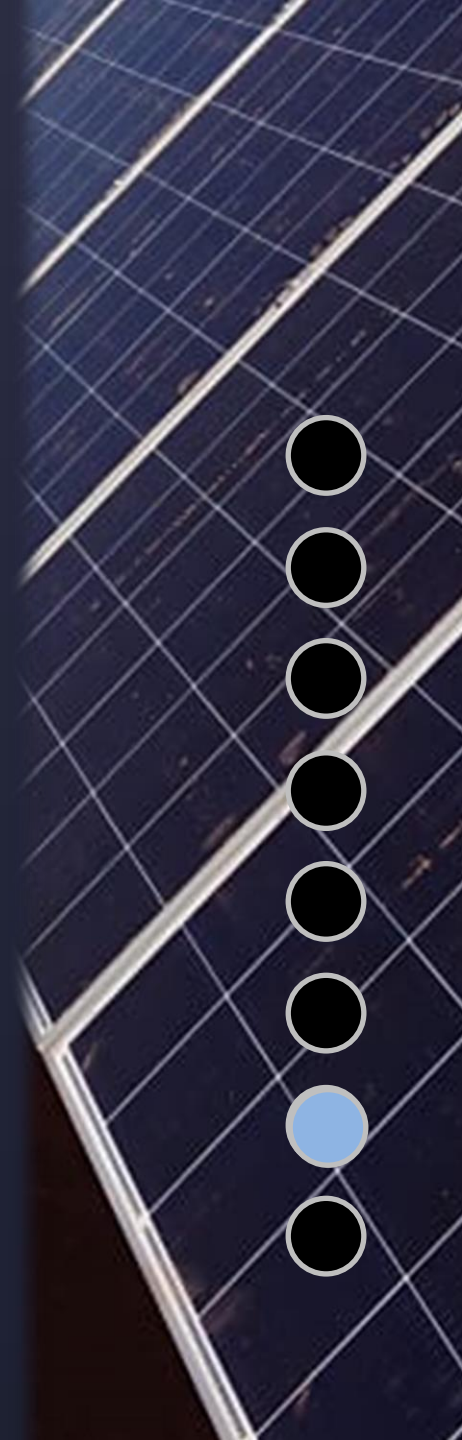

Impression of the system

Track references

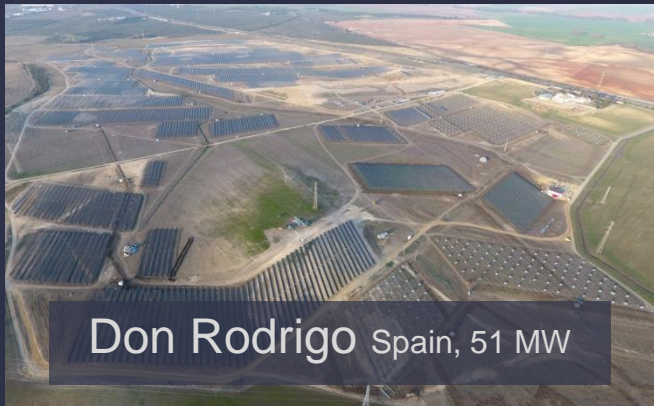

Don Rodrigo Spain, 51 MW



Granny Smith Australia, 8 MW



Kayseri Turkey, 5 MW



Mollèges France, 3 MW

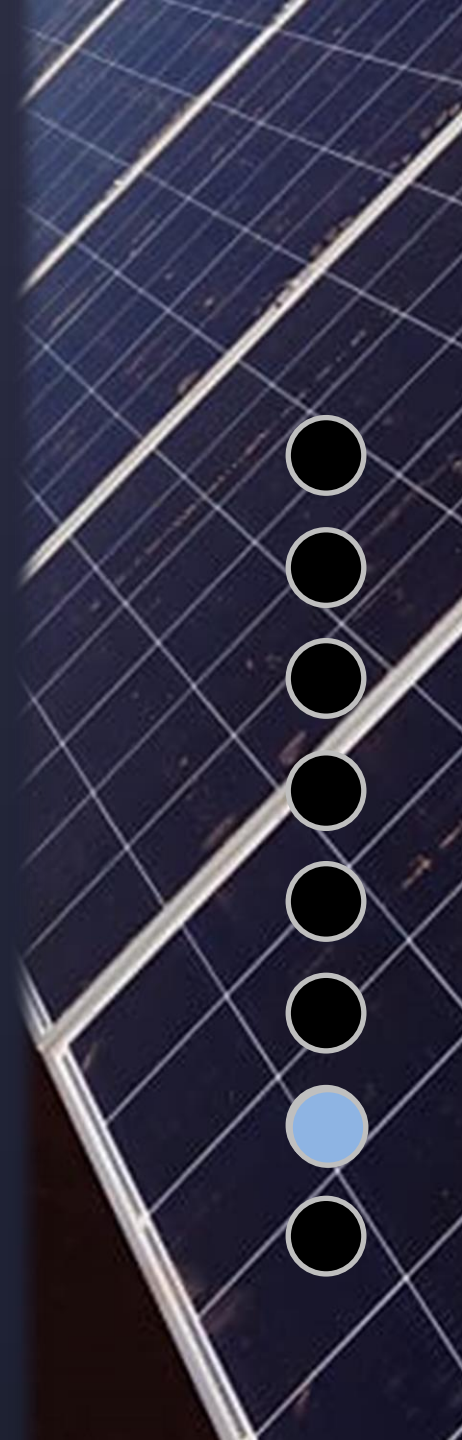

Summary and Outlook

ZIM Track – now and in future

- The ZM-Single-Axis Tracker System is a state of the art, high quality PV Tracker System.
- The Installation of the system and commissioning is fast, easy and safe.
- Due to innovative design the cost of installation, maintenance and operation can be held to a minimum.
- With a comprehensive quality and warranty statement and innovative design of the components, the Zim Track shows clear advantages in comparison to many competitors.
- In line with the philosophy of Zimmermann, the current system will be further optimised in order to reduce costs and improve quality.
- Continuing developments on tracker systems are already scheduled.

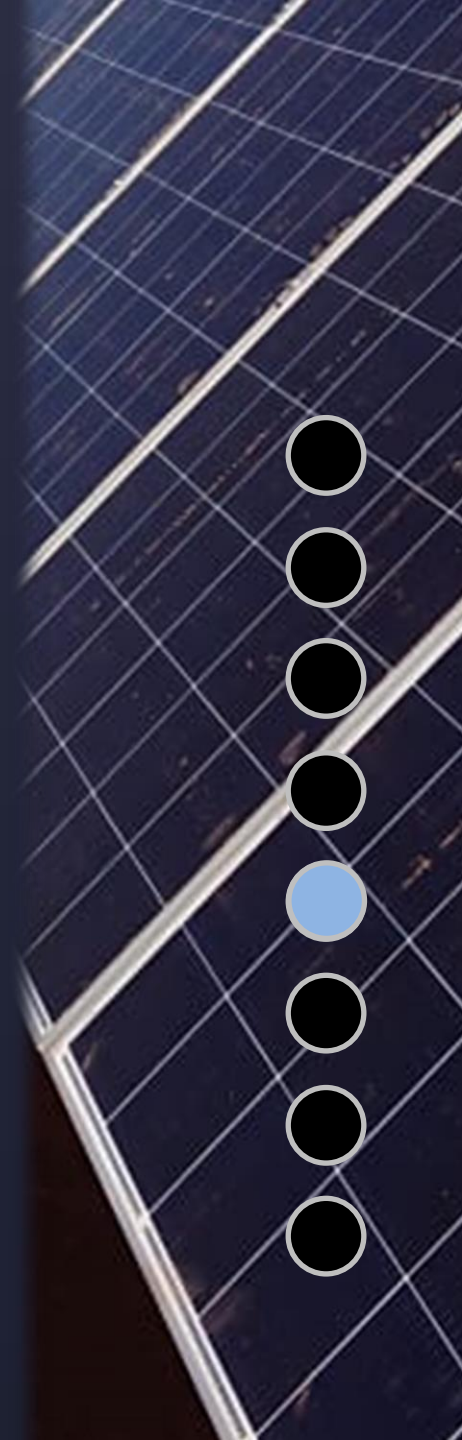



World's leading inverter platform

Like other FIMER central inverters, the PVS980-58 has been developed on the basis of decades of experience in the industry and proven technology platform. Unrivalled expertise from the world's market and technology leader in frequency converters is the hallmark of this solar inverter series.

The PVS980-58 inverter is one of the most efficient and cost-effective ways of converting the direct current (DC) generated by solar modules into high quality and CO₂-free alternating current (AC) that can be fed into the power distribution network.

PVS980-58 central inverters from FIMER

PVS980-58 central inverters are ideal for large PV power plants. The high DC input voltage, high efficiency, proven components, compact and modular design and a host of life cycle services

ensure FIMER PVS980-58 central inverters provide a rapid return on investment.

Highlights

- High total performance
- Outstanding endurance for outdoor use
- Compact, modular product design
- High DC input voltage up to 1500 V_{DC}
- Extensive DC and AC side protection
- Self-contained cooling system with high efficiency
- Versatile design for large-scale PV plants to minimize system costs
- Complete range of industrial data communication options, including remote monitoring
- Life cycle service and support through FIMER's extensive global service network solar inverters



Maximum energy revenues

FIMER central inverters have a high total efficiency. Precise, optimized system control and maximum power point tracking (MPPT) combined with the unit's highly efficient power converter design deliver the maximum energy from the PV modules to the power distribution network. For end users, this generates the highest possible revenues from the energy sales.

Self-contained, low-maintenance cooling system

PVS980-58 inverters feature a proven closed loop cooling system used in other industrial applications.

This innovative, low-maintenance cooling solution is designed for demanding applications and harsh environments, cutting maintenance costs and ensuring outstanding endurance.

Compact and modular design

PVS980-58 inverters are designed for fast and easy installation. The industrial design and modular platform provide a wide range of options, such as remote monitoring, fieldbus connection and modular and flexible DC input connections.

The integrated DC cabinet saves space and costs as the solar array junction boxes can be connected directly to the fused busbars in the DC cabinet. PVS980-58 inverters are customized

for the needs of end users and will be available with short delivery times.

Versatile design for large-scale PV plants to minimize system costs

FIMER's PVS980-58 central inverters enable system integrators to design PV power plants that use the optimum combination of inverters with different power ratings. Equipped with extensive electrical and mechanical protection, the inverters are engineered to provide a long and reliable service life of at least 25 years.

Advanced grid support features

The PVS980-58 software includes all the latest grid support and monitoring features, including active power limitation, fault ride through (FRT) with current feed-in and reactive power control.

Active and reactive power output can be controlled by an external control system or automatically by the inverter. All grid support functions are parameterized, allowing easy adjusting for local utility requirements. FIMER central inverters are also able to support grid stability at night by providing reactive power with the DC input disconnected.

Technical data and types

Product Type designation	PVS980-58 2.0 MVA -1818kVA-I	PVS980-58 2.1 MVA -1909kVA-J	PVS980-58 2.2 MVA -2000kVA-K	PVS980-58 2.3 MVA -2091kVA-L
Input (DC)				
Maximum recommended PV power ($P_{PV, max}$) ¹⁾	2909 kWp	3056 kWp	3200 kWp	3346 kWp
Maximum DC current ($I_{max(DC)}$)	2400 A	2400 A	2400 A	2400 A
DC voltage range, mpp ($U_{DC, mpp}$) at 35 °C	850 to 1500 V	893 to 1500 V	935 to 1500 V	978 to 1500 V
DC voltage range, mpp ($U_{DC, mpp}$) at 50 °C	850 to 1100 V	893 to 1100 V	935 to 1100 V	978 to 1100 V
Maximum DC voltage ($U_{max(DC)}$)	1500 V	1500 V	1500 V	1500 V
Number of MPPT trackers	1	1	1	1
Number of protected DC inputs	8 ²⁾ to 24 (+/-)	8 ²⁾ to 24 (+/-)	8 ²⁾ to 24 (+/-)	8 ²⁾ to 24 (+/-)
Output (AC)				
Maximum power ($S_{max(AC)}$) ³⁾	2000 kVA	2100 kVA	2200 kVA	2300 kVA
Nominal power ($S_{N(AC)}$) ⁴⁾	1818 kVA	1909 kVA	2000 kVA	2091 kVA
Maximum AC current ($I_{max(AC)}$)	1925 A	1925 A	1925 A	1925 A
Nominal AC current ($I_{N(AC)}$)	1750 A	1750 A	1750 A	1750 A
Nominal output voltage ($U_{N(AC)}$) ⁵⁾	600 V	630 V	660 V	690 V
Output frequency ⁵⁾	50/60 Hz	50/60 Hz	50/60 Hz	50/60 Hz
Harmonic distortion, current ⁶⁾	< 3%	< 3%	< 3%	< 3%
Distribution network type ⁷⁾	TN and IT	TN and IT	TN and IT	TN and IT
Efficiency				
Maximum ⁸⁾	98.8%	98.8%	98.8%	98.8%
Euro-eta ⁸⁾	98.6%	98.6%	98.6%	98.6%
CEC efficiency ⁹⁾	98.0%	98.5%	98.5%	98.5%
Power consumption				
Self consumption in normal operation	≤ 2500 W	≤ 2500 W	≤ 2500 W	≤ 2500 W
Standby operation consumption	235 W	235 W	235 W	235 W
Auxiliary voltage source ¹⁰⁾	External, 1-phase	External, 1-phase	External, 1-phase	External, 1-phase

¹⁾ DC/AC ratio over 1.6 might decrease maintenance intervals

²⁾ As standard

³⁾ At 35 °C

⁴⁾ At 50 °C

⁵⁾ ±10%

⁶⁾ At nominal power

⁷⁾ Inverter side must be IT type

⁸⁾ Without auxiliary power consumption at min U_{DC}

⁹⁾ With auxiliary power included

¹⁰⁾ Internal as option

Technical data and types

Product Type designation	PVS980-58 2.0 MVA -1818kVA-I	PVS980-58 2.1 MVA -1909kVA-J	PVS980-58 2.2 MVA -2000kVA-K	PVS980-58 2.3 MVA -2091kVA-L
Environmental limits				
Degree of protection				IP66 ¹¹⁾ / UL Type 3R
Ambient temp. range (nom. ratings) ¹²⁾				-20 °C to +50 °C
Maximum ambient temperature ¹³⁾				+60 °C
Relative humidity				5% to 100%
Maximum altitude (above sea level)				4000 m ¹⁴⁾
Typical sound pressure level (at 1 m distance)				< 75 dB (A) ¹⁵⁾
Maximum sound pressure level (at 1 m distance)				< 88 dB (A) ¹⁵⁾
Local user interface				Control panel
Analog inputs				2 as standard
Digital inputs/relay outputs				7/1 as standard
Fieldbus connectivity				Modbus, Profinet, Ethernet ¹⁶⁾
Product compliance				
Safety and EMC ¹⁶⁾	CE conformity according to LV and EMC directives			
Certifications and approvals	IEC, UL, CSA, RCM, IEEE, BDEW, CEI, SAGC, FCC and more			
Grid support and grid functions	Reactive power compensation ¹⁷⁾ , Power reduction, LVRT, HVRT, FqRT			
Dimensions and weight				
Width/Height/Depth, mm (W/H/D)	3180/2443/1522	3180/2443/1522	3180/2443/1522	3180/2443/1522
Weight appr.	3500 kg	3500 kg	3500 kg	3500 kg

¹¹⁾ Excluding underpressure testing, IP56 with underpressure
¹²⁾ -40 °C as option
¹³⁾ Power derating after 50 °C
¹⁴⁾ Power derating above 1000 m

¹⁵⁾ A - weighted
¹⁶⁾ More communication options as engineered option
¹⁷⁾ Also at night

PVS980-58 central inverter block diagram

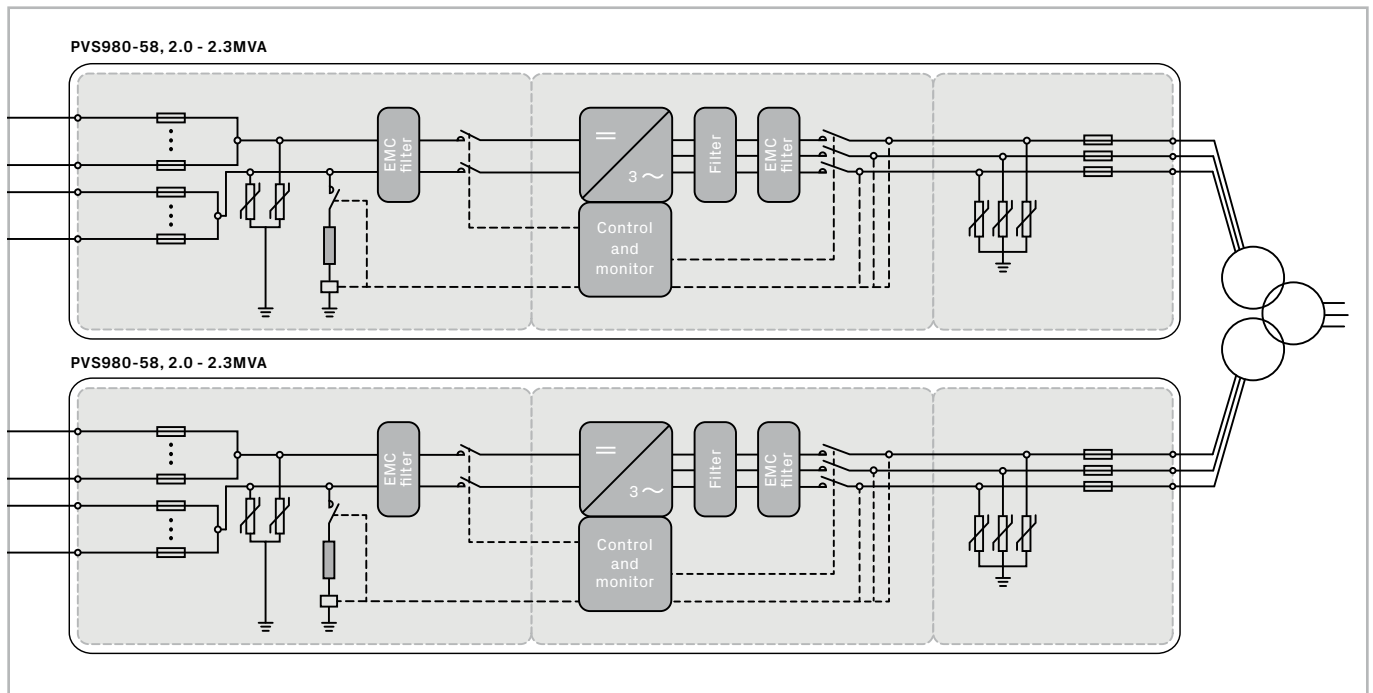

Central inverter

PVS980-58 from 1818 to 2091 kVA



High total performance

- High efficiency
- Low auxiliary power consumption
- Innovative controlled cooling
- Efficient maximum power point tracking
- Long and reliable service life of at least 25 years

Outstanding endurance for outdoor use

- Water- and dustproof outdoor enclosure
- Designed to withstand the toughest environments
- Long and reliable service life following the FIMER life cycle model

Modular industrial design

- Compact and easy-to-maintain product design
- Fast and easy installation
- Integrated and flexible DC input section

Life cycle service and support

- FIMER's extensive global service network
- Extended warranties
- Service contracts
- Technical support throughout the service life

Self-contained cooling system

- Closed loop cooling system based on phase transition and thermosiphon technology
- Liquid-cooled inverter power ratings with the simplicity of air cooling
- No fillable liquids, pumps, valves, inhibitors or leaks
- Low maintenance

Versatile design for largescale PV plants

- Integrated DC connection with variable number of inputs
- Wide standard option palette for tailoring
- Versatile AC connection methods

Minimizes system costs

- 1500 V_{DC} system voltage
- Wide ranged and highly efficient MPPT algorithm
- Integrated protection to minimize external components
- Fast and easy installation and commissioning

Wide communication options

- Complete range of industrial data communication options for SCADA connections
- Ethernet/Internet Protocol
- Remote monitoring

Comprehensive simulation models

- PSS/E
- PSCAD
- DigSilent

Data communication principle for PVS980-58 central inverter

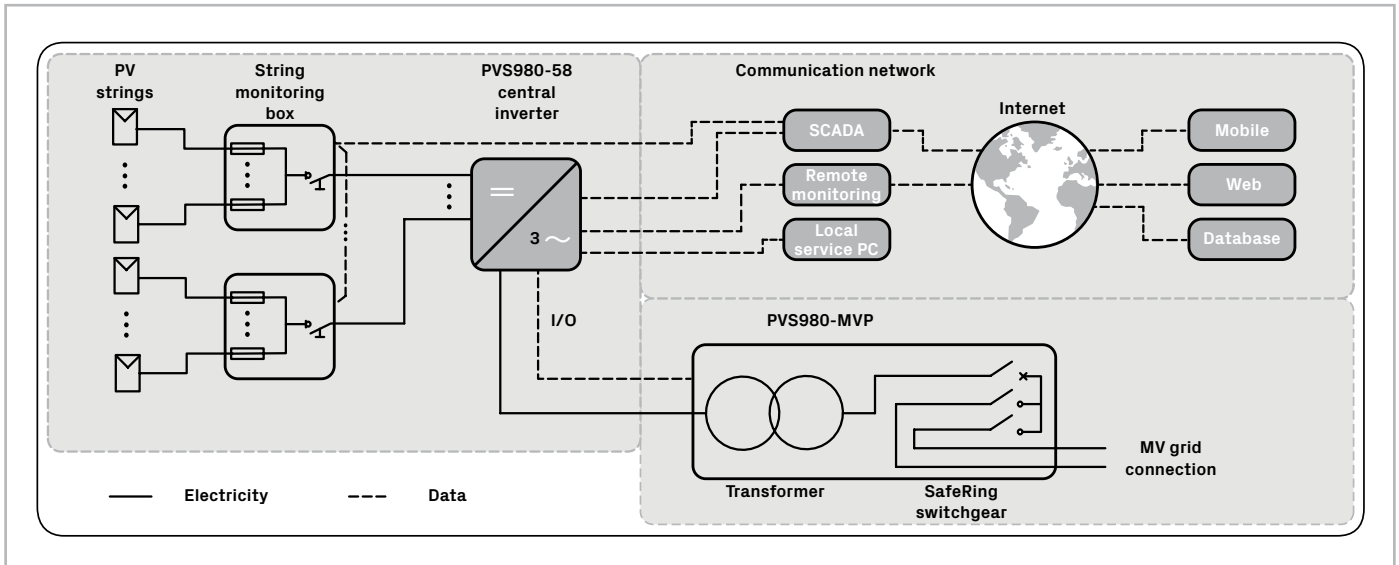

Options

- Integrated and flexible DC input extension
- AC breaker
- AC disconnecter switch
- DC disconnecter switch
- Heavy duty (Type 1) surge protection
- AC busbar interface
- Internal auxiliary power supply
- DC grounding, positive
- Floating DC
- Fieldbus and Ethernet connections
- Current measurement to each DC input
- High altitude version
- Low temperature version
- Warranty extensions
- Solar inverter care contracts
- DC/AC ratio higher than 1.6

Related products

- Medium voltage station (transformer and switchgear) as outdoor or containerized solution
- String monitoring junction boxes
- Remote monitoring solutions

Support and service

FIMER supports its customers with a global service network and provides a complete range of life cycle services from installation and commissioning to preventative maintenance, spare parts, repairs and recycling.



For more information please contact your local FIMER representative or visit:

fimer.com

We reserve the right to make technical changes or modify the contents of this document without prior notice. With regard to purchase orders, the agreed particulars shall prevail. FIMER does not accept any responsibility whatsoever for potential errors or possible lack of information in this document.

We reserve all rights in this document and in the subject matter and illustrations contained therein. Any reproduction, disclosure to third parties or utilization of its contents – in whole or in parts – is forbidden without prior written consent of FIMER. Copyright© 2021 FIMER. All rights reserved.

